

Pneumatic Tools

Extended Spindle Straight Grinders

Application Sectors

- Aerospace
- Automotive
- Fabrication
- Foundries

Recommended Consumables

- Tungsten Carbide Burrs
- Mounted Points
- Flap Wheels
- Abrasive Bands

Key Points

- A wide range of speeds and spindle configurations for grinding in hard to reach areas
- Compact high power tool for single handed operation

Areas of Use

All types of grinding, deburring, finishing and polishing in areas with restricted access



SD37LR-125

SD26L-ES

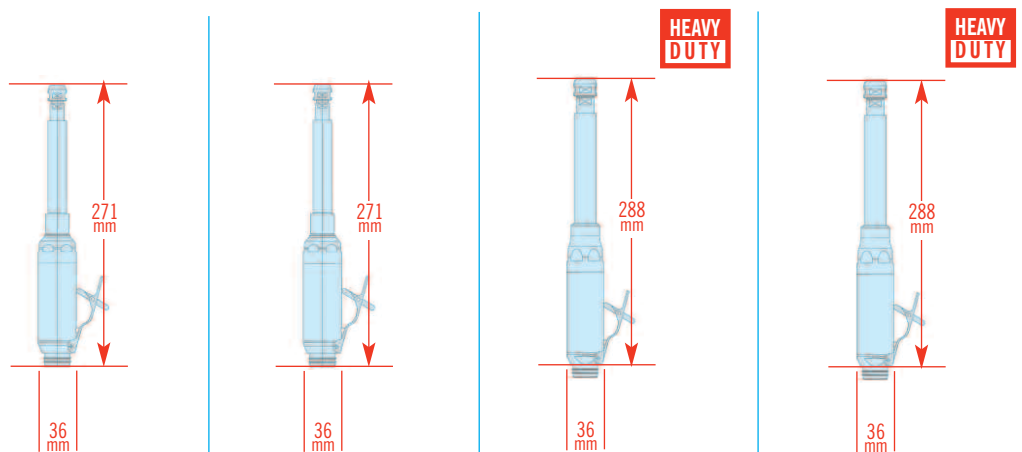

Model Ref.	SD37LR-125	SD30LR-125	SDH37LR-150	SDH30LR-150
Speed (rpm)	37,000	30,000	37,000	30,000
Power	0.30kW / 0.40Hp	0.30kW / 0.40Hp	0.30kW / 0.40Hp	0.30kW / 0.40Hp
Weight (kgs)	0.54	0.54	0.82	0.82
Noise Level (dbA)	74	73	73	73
Standard Collet (mm)	6 (Type CB)	6 (Type CB)	6 (Type CA)	6 (Type CA)
Air Usage (m ³ /min)	0.57	0.57	0.57	0.57
Exhaust	Rear	Rear	Rear	Rear
Control	Lever throttle	Lever throttle	Lever throttle	Lever throttle
Hose	Included-1/4"	Included-1/4"	Included-1/4"	Included-1/4"

Extended Spindle Straight Grinders

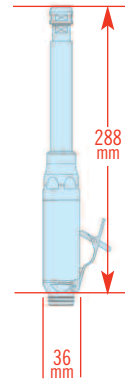
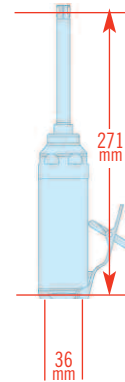
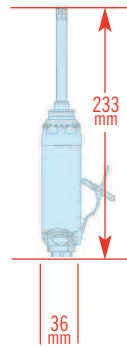

Model Ref.	SD26L-ES	SD26LR-ES	SD26LR-125	SDH26LR-150
Speed (rpm)	25,000	25,000	25,000	25,000
Power	0.30kW / 0.40Hp	0.30kW / 0.40Hp	0.30kW / 0.40Hp	0.30kW / 0.40Hp
Weight (kgs)	0.45	0.45	0.54	0.82
Noise Level (dbA)	72	72	72	72
Standard Collet (mm)	3 (Type CD)	3 (Type CD)	6 (Type CB)	6 (Type CA)
Air Usage (m ³ /min)	0.57	0.57	0.57	0.57
Exhaust	Front	Rear	Rear	Rear
Control	Lever throttle	Lever throttle	Lever throttle	Lever throttle
Hose	Option-1/4"	Included-1/4"	Included-1/4"	Included-1/4"

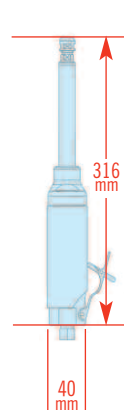

Model Ref.	SX22LR	SX22LR/2	SX22LR/2-3
Speed (rpm)	22,000	22,000	22,000
Power	0.63kW / 0.85Hp	0.63kW / 0.85Hp	0.63kW / 0.85Hp
Weight (kgs)	1.17	1.27	1.27
Noise Level (dbA)	70	70	70
Standard Collet (mm)	6 (Type CB)	6 (Type CA)	6 (Type CB)
Air Usage (m ³ /min)	0.85	0.85	0.85
Exhaust	Rear	Rear	Rear
Control	Lever throttle	Lever throttle	Lever throttle
Hose	Included-1/4"	Included-1/4"	Included-1/4"

Extended Spindle Straight Grinders

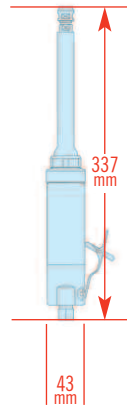

Model Ref.	SX16LR	SX16LR/2	SX16LR/2-3
Speed (rpm)	16,000	16,000	16,000
Power	0.63kW / 0.85Hp	0.63kW / 0.85Hp	0.63kW / 0.85Hp
Weight (kgs)	1.17	1.27	1.27
Noise Level (dbA)	65	65	65
Standard Collet (mm)	6 (Type CB)	6 (Type CA)	6 (Type CB)
Air Usage (m ³ /min)	0.85	0.85	0.85
Exhaust	Rear	Rear	Rear
Control	Lever throttle	Lever throttle	Lever throttle
Hose	Included-1/4"	Included-1/4"	Included-1/4"

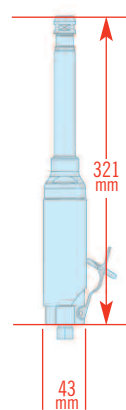
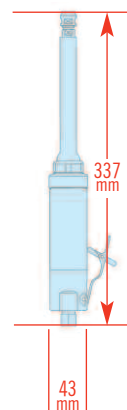

Model Ref.	SX10LR	SX10LR/2	SX10LR/2-3
Speed (rpm)	10,000	10,000	10,000
Power	0.63kW / 0.85Hp	0.63kW / 0.85Hp	0.63kW / 0.85Hp
Weight (kgs)	1.17	1.27	1.27
Noise Level (dbA)	64	64	64
Standard Collet (mm)	6 (Type CB)	6 (Type CA)	6 (Type CB)
Air Usage (m ³ /min)	0.85	0.85	0.85
Exhaust	Rear	Rear	Rear
Control	Lever throttle	Lever throttle	Lever throttle
Hose	Included-1/4"	Included-1/4"	Included-1/4"